

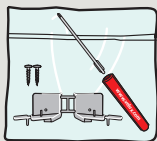

VELUX®

**FHLC/FHLD
FHCC/FHCD**

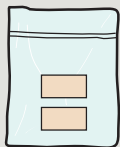
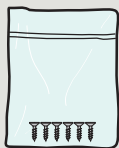
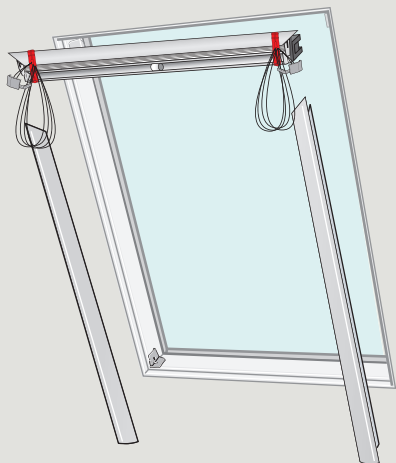

VAS 453787-2015-04



Ø 1/16" / 1.5 mm

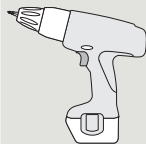

1

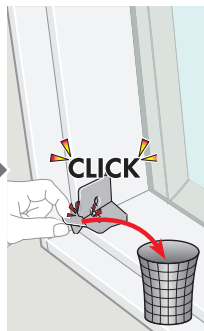
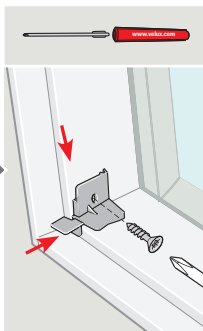
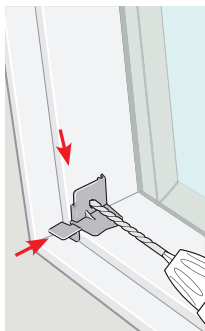
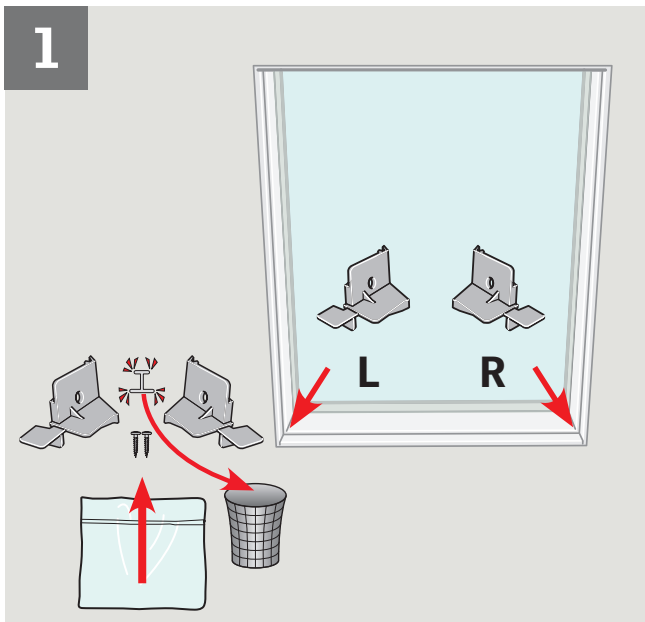

ENGLISH: Installation of the blind can be done in two ways:

A With most skylights, the top part and the sides of the blind are installed individually - see pages 6-7.

Note: If the skylight can be opened, this may ease the installation of the sides of the blind.

B With skylight **FS** in the sizes listed, the blind must be partially assembled before installation in the skylight - see pages 8-9.

ESPAÑOL: La instalación de la persiana puede hacerse de dos maneras:

A Con la mayoría de los tragaluces, la parte superior y los lados de la persiana se instalan de manera individual. Consulte las páginas 6-7.

Nota : Si el tragaluz puede abrirse, la instalación de los lados de la persiana resulta más sencilla.

B Con el tragaluz **FS** en los tamaños mencionados, la persiana debe ensamblarse parcialmente antes de instalarla en el tragaluz. Consulte las páginas 8-9.

FRANÇAIS : Installation du store peut être effectué de deux manières :

A Pour la plupart des puits de lumières, la partie supérieure et les côtés du store sont installés individuellement - voir pages 6-7.

Remarque: Si le puits de lumière peut être ouvert, cela peut faciliter l'installation des côtés du store.

B Pour le puits de lumière **FS** dans les tailles indiquées, le store doit être partiellement assemblé avant l'installation dans le puits de lumière - voir pages 8-9.

日本語: ブラインドの取り付けには以下の2方式があります。

A ほとんどの天窓では、ブラインド本体と左右のレールを別々に取り付けます。 - 6-7ページ参照。
この時点で天窓が開けられれば、作業がし易くなります。

B FSフィックスタイプで表のサイズの場合は、ブラインド本体と左右のレールを、図のように仮組をしてから取り付けます。 - 8-9ページ参照。

A

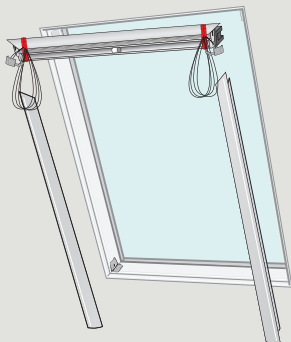

Pages
6-7

B

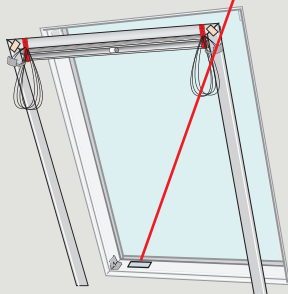

FS A06
FS C01
FS C04
FS D26
FS M02
FS M04
FS M25
FS S25
FS S01

Pages
8-9

2A

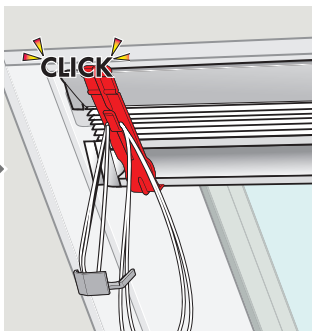
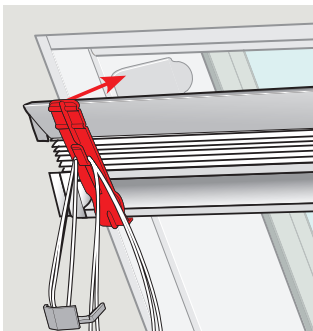
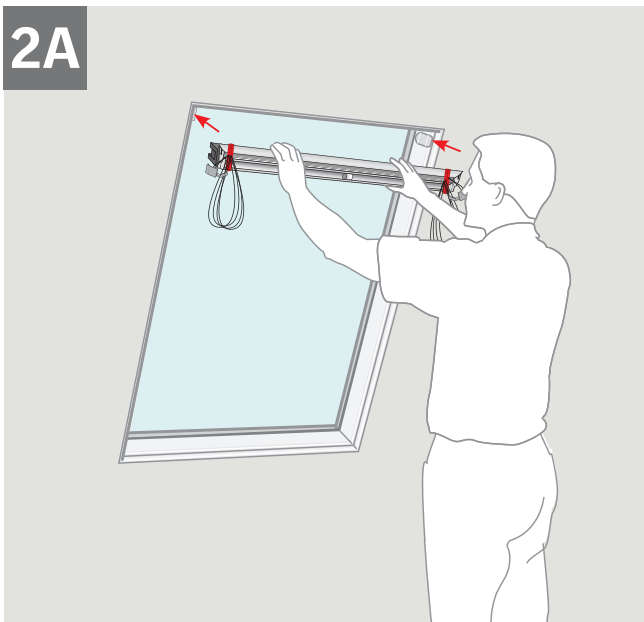

3A

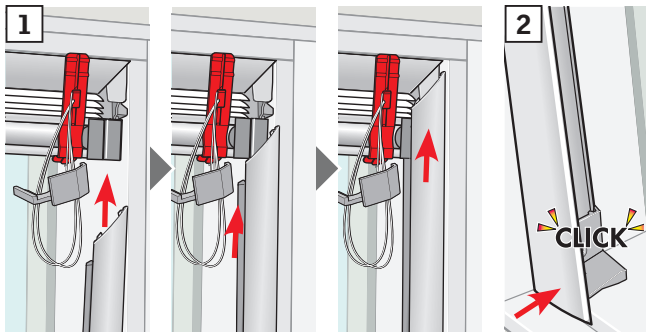
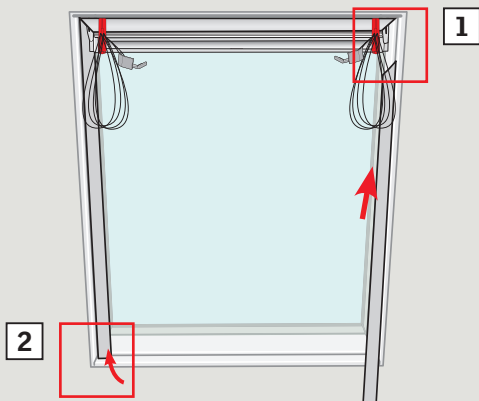

2B

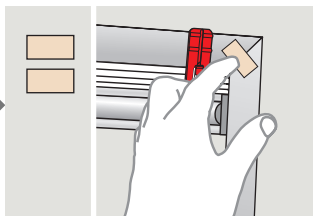
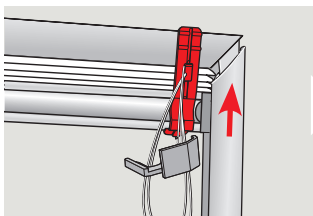
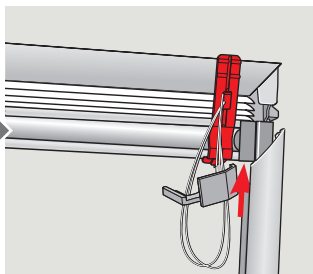
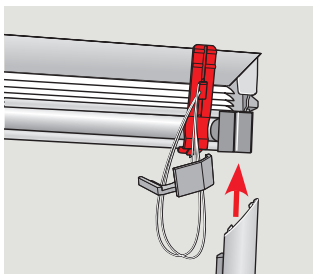
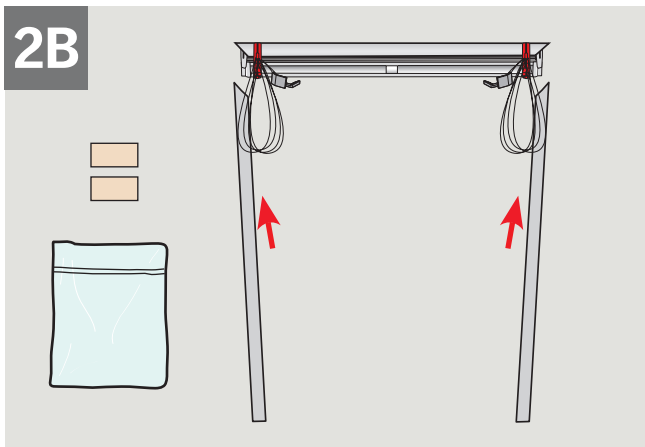

3B

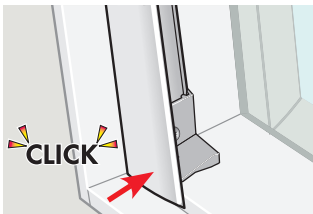
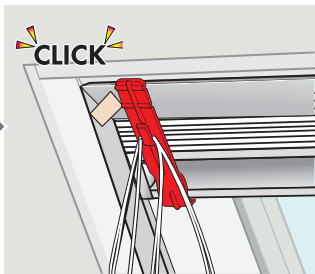
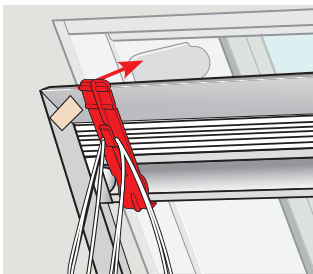
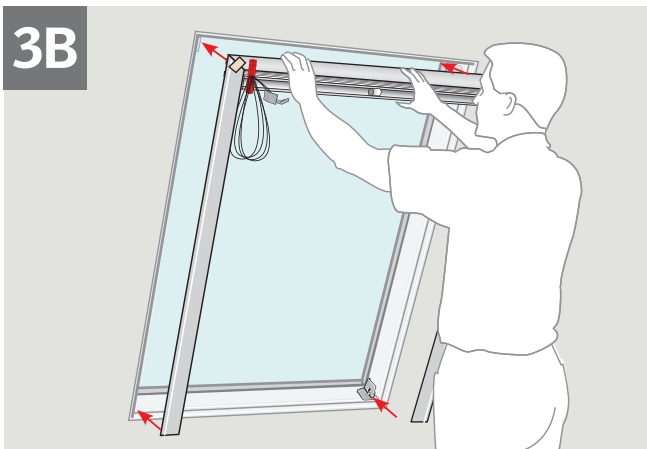

4

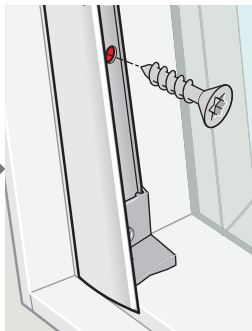
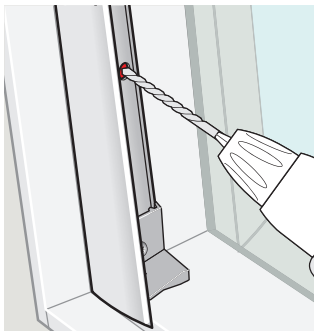
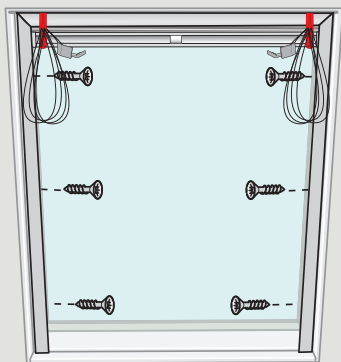
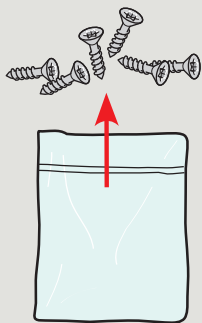

5

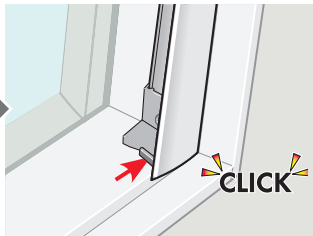
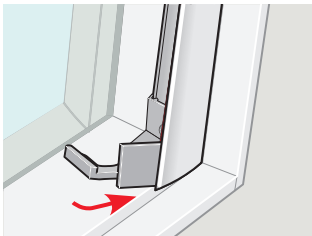
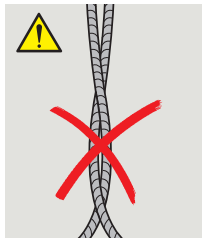
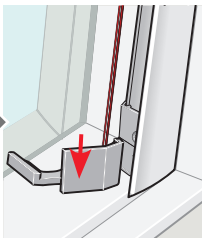
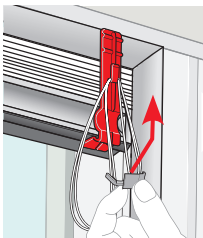
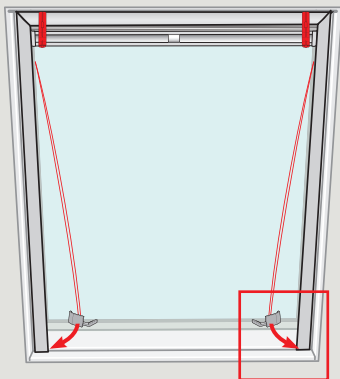

6

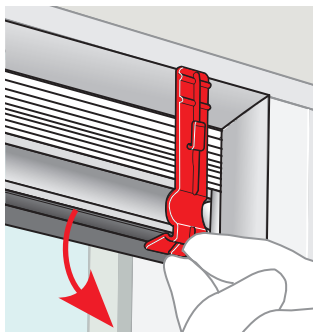
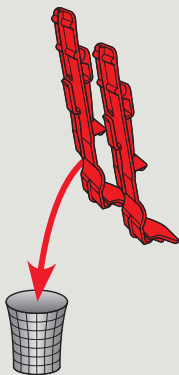
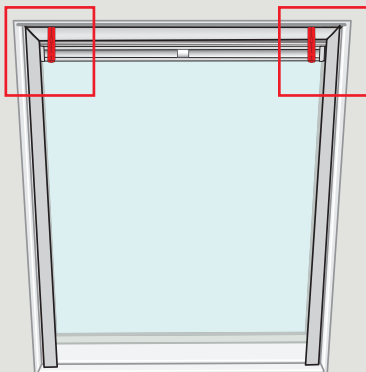



ZXT 200

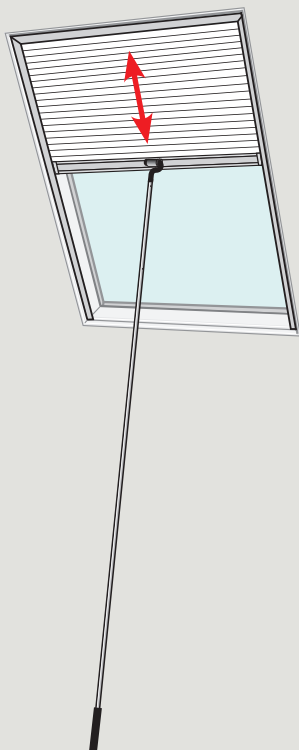

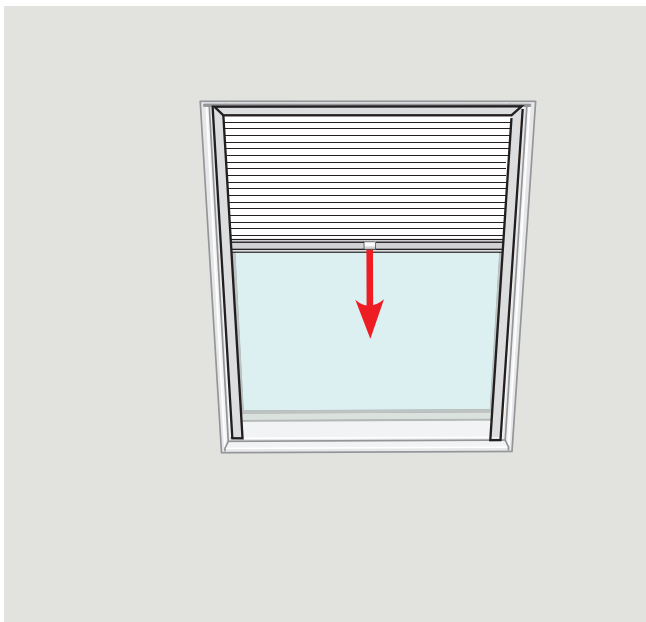

The logo consists of the word "VELUX" in a bold, white, sans-serif font, with a registered trademark symbol (®) to the upper right of the "X". The text is centered within a solid red rectangular background.

- US:** VELUX America Inc.
1-800-88-VELUX
- CD:** VELUX Canada Inc.
1 800 88-VELUX (888-3589)
- AU:** VELUX Australia Pty. Ltd
1300 859 856
- NZ:** VELUX New Zealand Ltd.
0800 650 445
- JP:** VELUX-Japan Ltd.
0570-00-8145

www.velux.com